

**ASSISTANCE CENTRE
AUTHORIZED RETAILER**

Softcooker Y09

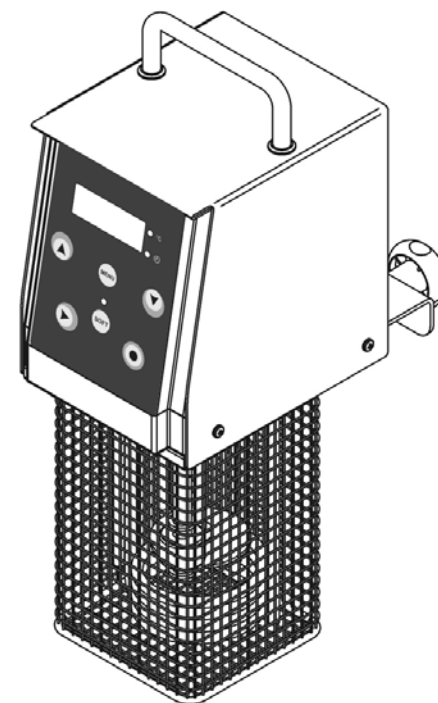

Softcooker Ed. 02/2010

English

PART 8 - DISMANTLING

8.1 – Putting out of service

Should you decide to put the machine out of service, make sure it cannot be used by anyone: **unplug the machine and disconnect all the electrical connections.**

8.2 - Disposal

Once the machine has been put out of service, it can be eliminated in due course. To dispose of the machine correctly, contact a waste disposal firm taking into account the various materials that make up the various components.

8.3 - WEEE Waste electrical and electronic equipment



In conformity with article 13 of Legislative Decree no. 151 of 25 July 2005, “Implementation of the Directives 2002/95/EC, 2002/96/EC and 2003/108/EC concerning the reduction of the use of hazardous substances in electrical and electronic equipment, and the disposal of waste”

The symbol of the crossed out wheelie bin on the equipment or packaging indicates the product must be disposed of separately from other waste at the end of its useful life.

The segregated collection of this equipment at the end of its useful life is organized and arranged by the producer. The user wishing to dispose of the equipment concerned must therefore contact the producer and follow the manufacturer’s instructions regarding the segregated collection of the equipment at the end of its useful life.

Suitable segregated collection of the equipment for subsequent recycling, treatment or environmentally friendly disposal helps prevent damage to the environment and to human health, and encourages the re-use and/or recycling of the materials that make up the equipment.

Abusive disposal of the product by the user shall result in the application of fines in accordance with the law in force.

PART 6 – CLEANING THE MACHINE

ATTENTION! Always unplug the machine before cleaning it to ensure it is no longer live.

6.1 – General point

- Clean the machine with a cloth soaked in a normal detergent at ambient temperature.
- Clean thoroughly all parts of the machine that come in contact with the product.
- Do not use high-pressure water jet machine or pressurized water spray.
- Do not use tools, brushes or other that could damage the surface of the machine.
- Do not put any of the components in the dishwasher.

6.2 – Maintenance of the element

To protect the element and all the components that are immersed in the tank, you are advised to add some vinegar in the tank with the water for each work cycle.

PART 7 - MAINTENANCE

7.1 - General point

Always **unplug** the machine before servicing it to ensure it is no longer live.

7.2 - Power cable

Check the cable regularly to ensure it is in good condition. Call the ASSISTANCE CENTRE if the cable needs to be replaced.

FOREWORD

- This manual was drawn up to provide the Customer with information concerning the machine and applicable standards, as well as instructions on operation and maintenance to ensure the optimal use and durability of the device.
- **This manual is intended for operators authorized to use the machine and execute routine maintenance.**

LIST OF CONTENTS

PART 1 - ABOUT THE MACHINE	5
1.1 - General precautions	
1.2 - The machine's safety devices	
1.3 - Description of the machine	
1.3.1 - Overview	
1.3.2 - Structural characteristics	
1.4 - Intended use	
1.5 - Unintended use	
1.6 - Master data	
1.7 - Protective and safety devices	
1.8 - Machine composition	
PART 2 - TECHNICAL DATA	9
2.1 - Size, weight, properties...	
PART 3 - RECEIPT OF THE MACHINE	10
3.1 - Delivery of the machine	
3.2 - Checking the pack on receipt	
3.3 - Disposal of the packaging	
PART 4 - INSTALLATION	11
4.1 - Positioning of the machine	
4.2 - Connection to the mains	
4.3 - Wiring diagram	
PART 5 - MACHINE USE	12
5.1 - Controls	
PART 6 - CLEANING THE MACHINE	14
6.1 - General point	
6.2 - Maintenance of the element	

PART 7 - MAINTENANCE

- 7.1 - General point
- 7.2 - Power cable

PART 8 - DISMANTLING

- 8.1 - Putting out of service
- 8.2 - Disposal
- 8.3 - WEEE Waste electrical and electronic equipment

14

 **Timer Led** : this is at the side of the display and lights up when the work time is shown on the display during the work cycle.

15

 **UP and DOWN buttons (+/-)**: use these to configure the temperature and time. Press the start button to start the work cycle.

 **MENU** button: press this to configure the work cycle.

- Press the Menu button once to access temperature configuration. Use the UP and DOWN buttons to select the required temperature. Press the Menu button to confirm and save the temperature to be reached.
- The time to be configured is then shown on the display. Use the UP and DOWN buttons to select the required cooking temperature. Press the Menu button again to confirm and save your changes. This is the machine work time starting from the attainment of the temperature described above.
- The word **GO** then appears on the display. Press the START button to start the work cycle.

 **SOFT** button for energy efficiency operation. Pushing this button helps you saving energy and money. Light is on when in use.

You will hear the BUZZER when the machine reaches the set temperature, regardless of whether you have configured the time.

When the work cycle has ended, press the STOP button to turn off the machine.

Unplug the machine. Disconnect the machine from the tank. Empty the tank.

The Softcooker gives an error message when:

- The level of water in the container is too low (ERR),
- The electronic components in the machine start to overheat (ERR),
- The temperature probes do not detect the same temperature as one of the two probes is faulty (ERR).

4.3 - Wiring diagram

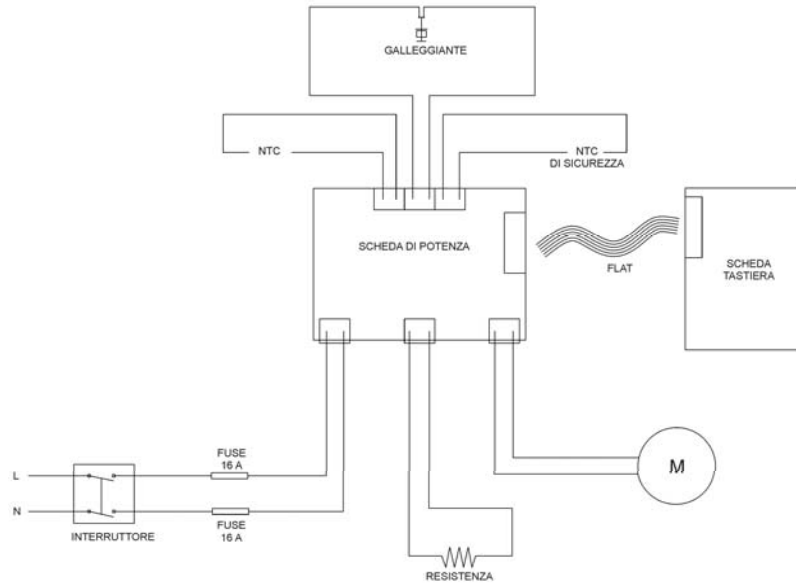

PART 5 - MACHINE USE

5.1 - Controls

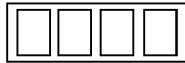

Display: a four-digit display that gives the temperature and time, with alternate every 5 seconds, and a description of the various pre-configured programs.



START button: press to start the work cycle.



OFF button: press to stop the work cycle.

 **°C Temperature LED:** this is at the side of the display and lights up when the work temperature is shown on the display during the work cycle.

PART 1 - ABOUT THE MACHINE

1.1 - GENERAL PRECAUTIONS

- The SOFTCOOKER must only ever be used by a trained operator who has read and understood the safety instructions in this manual.
- In the case of shifts, make sure all the operators are suitably trained.
- Do not touch the heating elements with bare hands.
- **Always unplug the machine before cleaning or maintenance.**
- Always take the residual risks into account when servicing or cleaning the machine (and therefore when removing the protective devices).
- Always focus on the work in hand when executing maintenance or cleaning.
- Check the condition of the power cable on a regular basis; a worn or damaged cable can pose serious electrical risks.
- If there are any signs the machine is not working properly or you have reason to believe it is malfunctioning, you are advised to not use it and to contact the Assistance Centre immediately.
- Do not execute any repairs directly. Always contact an authorized repairman.

The user must never, for any reason, tamper with the machine. Always contact the Manufacturer in the event of a fault. Any attempt by the user or unauthorized operator to dismantle, change or tamper with a component of the machine shall forfeit the

Declaration of Conformity drawn up in accordance with EEC Directive 2006/42 and invalidate the warranty. The Manufacturer Firm cannot assume liability for damage due to tampering.

Moreover, the Manufacturer cannot be held liable for:

- Improper use or tampering with the machine by poorly trained operators;
- Poor or insufficient maintenance;
- Use of spare parts that are **not original** or type-approved;
- Failure to comply with some or all of the instructions in this manual;
- Treatment of the machine's surfaces with unsuitable products.

1.2 - THE MACHINE'S SAFETY DEVICES

The electrical and mechanical safety devices conform to directives **2006/95** and **2006/42**, and standard **60335-1**.

The Softcooker protects against electrical and mechanical risks during operation as well as cleaning and maintenance.

There are however some **RESIDUAL RISKS** that cannot be fully eliminated. These are headed **ATTENTION** and concern the risk of burns or bruises when loading and unloading the product and cleaning the machine.

1.3 - DESCRIPTION OF THE MACHINE

1.3.1 - Overview

Our firm designed and constructed the Softcooker to guarantee the following:

- the sturdiness and stability of all the components;
- easy handling, with a stainless steel handle so it can be carried with convenience;
- high precision heating control;
- a circulation fan for excellent mixing of the product;
- a max work depth of 16.5 cm;
- optimal operation up to 50 litres;
- an operating temperature of between 20 and 100°, at a precision of +/- 0.3° C.

The models stated in this manual are constructed in conformity with **EEC Directive 2006/42** and subsequent amendments.

The manufacturer cannot assume any liability for accidents if the machine has been changed, tampered with, used without its safety devices or put to a use for which it was not intended.

1.3.2 - Structural characteristics

The Softcooker was made entirely of AISI 304 stainless steel to ensure hygiene and resistance to acids and salts, as well as excellent resistance to oxidation.

- The heating element consists of an electro-polished coated spiral element devised especially for immersion in water.
- A stainless steel handle for convenient handling of the machine.
- A motor circuit breaker that detects overvoltage and overheating.

1.4 – Intended use

The Softcooker is intended for vacuum cooking in a water-filled immersion tank. It does not cook food in any other way or heat liquids other than water.

3.3 - Disposal of the packaging

All the packaging (cardboard, plastic support and polyurethane foam) is classified as solid urban waste; it can be disposed of without difficulty. If the machine is installed in a country where there are specific regulations, you should dispose of the packaging in accordance with those regulations in force.

PART 4 - INSTALLATION

4.1 - Positioning of the machine

Fill the water tank. Make sure you put in more than the **minimum amount** required for machine operation (75 mm from the top of the tank) but do not exceed the **maximum level (20 mm from the top of the tank)**.

Connect the Softcooker to the immersion tank by means of the connector behind the machine.

Make sure the liquid does not enter the machine.

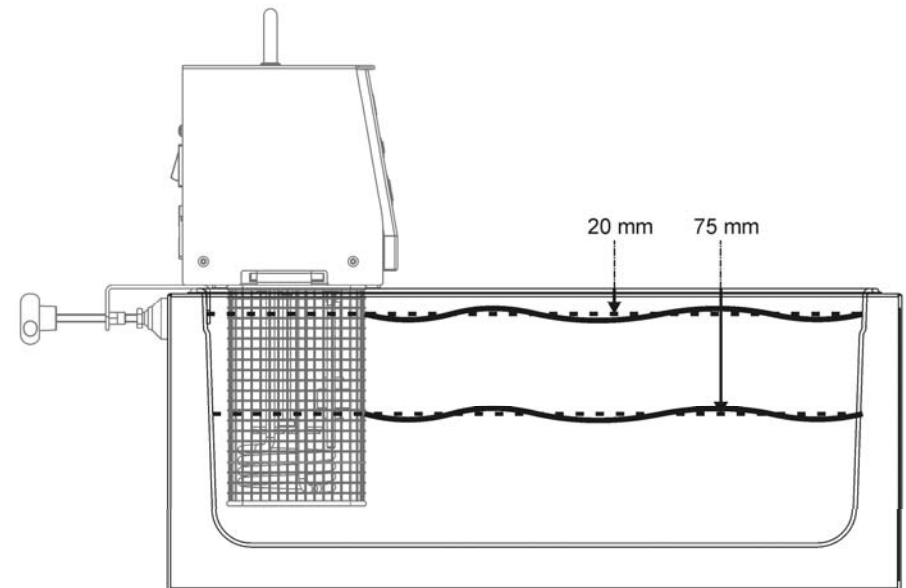

4.2 - Connection to the mains

A 3x1.5 mm² power cable 1.5 m in length and CEI plug is provided with the appliance. Connect the machine to a 230 Volt 50 Hz power supply. Check the data on the technical – serial number plate is the same as that stated in the delivery and accompanying documents. Make sure also that the switch and socket are easy to access when the appliance is in use.

PART 3 - RECEIPT OF THE MACHINE

3.1 - Delivery of the machine (refer to Fig.n°3)

The machinery is carefully packed before it leaves our warehouses.

The pack contains:

- A sturdy cardboard box with inside padding;
- The machine;
- This manual;

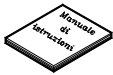
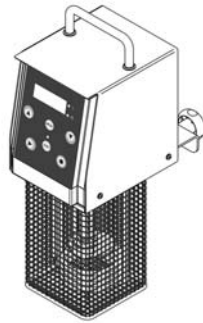
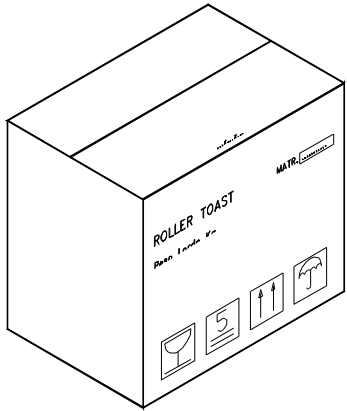

3.2 – Checking the pack upon receipt

When you receive the pack containing the machine, check the packaging carefully for any signs of damage it may have sustained during transport.

If the outer packaging looks as if it has been treated roughly, knocked or dropped, within three days of the date of delivery, as stated in the documents, and write a precise report on any damage the machine has sustained.

1.5 – Unintended use

The machine must be put to the sole use intended by the manufacturer; in particular:

- **Do not** use the machine unless it has been installed correctly and all the protective devices are in good condition and properly fitted, in order to prevent the risk of serious harm to yourself.
- **Do not** touch the electrical components without having first unplugged the machine: **risk of electrocution.**
- **Do not** start up the machine when this is not working properly.
- Before using the machine, make sure the machine is perfectly safe and that any dangerous conditions have been eliminated in an appropriate manner. If there are any irregularities, stop the machine and request the assistance of a maintenance technician.
- **Do not** allow unauthorized operators to use the machine.

Emergency action in the event of electrical accidents first of all, remove the victim from the conductor (as he is likely to be unconscious). This operation is dangerous.

The victim in this case is a conductor: touching him is to risk electrocution. It is advisable therefore to disconnect the contacts directly from the line supply valve, or if this is not possible, move the victim away using insulation materials (pieces of wood or PVC, cloth, leather, etc.).

The victim should be given immediate medical attention and taken to a hospital.

1.6 – Master data

Please state the machine's exact "**Model**", "**Serial number**" and "**Year of manufacture**" when contacting our assistance service. This will help us give you a quick and efficient response.

We will ask you to state the machine model and serial number whenever you contact us, so make sure to check this on the data plate, pictured in fig. 1.7.1.

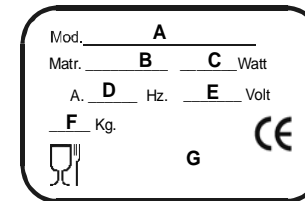

- A = machine model
- B = serial number
- C = motor power in Watts
- D = Ampère
- E = motor frequency in Volts
- F = machine weight in Kg
- G = producer

Fig. 1.7.1

1.7 – Protective and safety devices

ATTENTION!

Make sure the safety devices are in good condition and correctly installed before using the machine.

Check these before each work shift to ensure they are fitted and in order. If they are not, you should inform the person responsible for maintenance.

- **A Element protective cell:** this prevents contact with the element and fan which can seriously wound the operator.
- **B Automatic protective device in the case of dry operation:** the machine stops and an error (ERR) message appears on the screen when the level of the water falls below the minimum permitted (75 mm from the top of the immersion tank).
- **C Disabling device:** the machine stops and an error (HIGH) message appears on the screen when there is a fault with one of the probes and their temperature readings are different.

1.8 - Machine composition

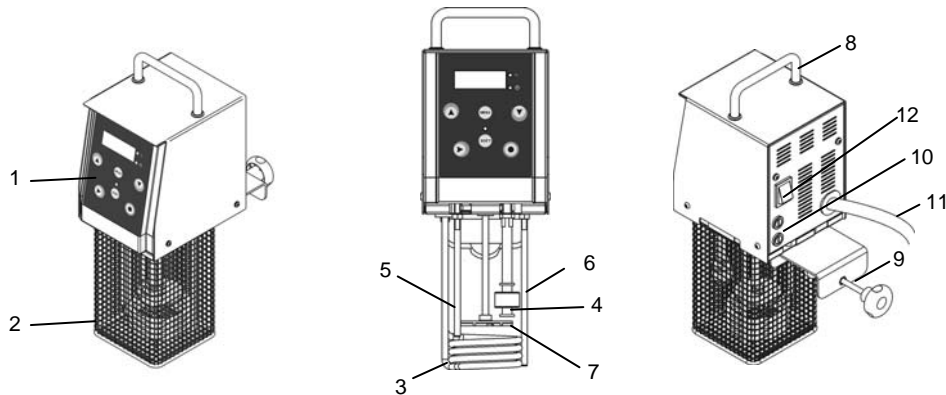

LEGEND

1	Front	7	Rotor
2	Protective cell on element	8	Handle
3	Element	9	Terminal
4	Float	10	Fuses
5	Probe	11	Cable
6	Safety probe	12	ON-OFF switch

PART 2 - TECHNICAL DATA

2.1 - Size, weight, properties...

Fig.n°2 – Dimensions and max size of the machine

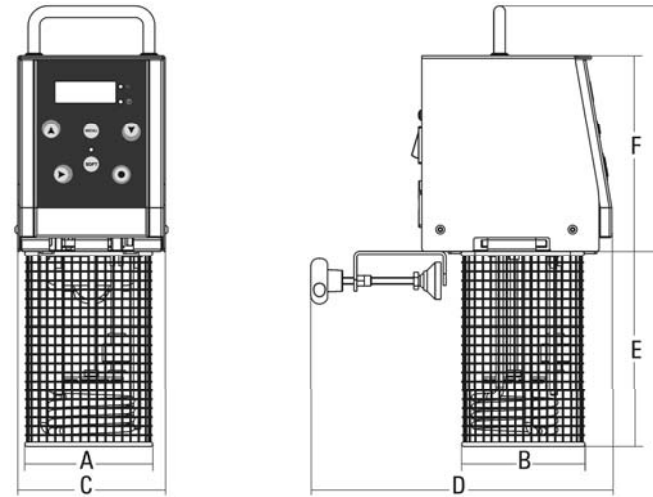

Model	Measure	Softcooker
Power	watt	2,000
Current		230V/50Hz
Temperature	°C	20 to 100
A x B	mm	110 x 105
C x D	mm	130 x 260
E / F / G	mm	170 / 170 / 210
Net weight	kg	4.5



ATTENTION

THE ELECTRICAL PROPERTIES OF THE MACHINE ARE STATED ON A PLATE ON ITS BACK; BEFORE CONNECTING THE MACHINE, REFER TO THE SECTION:
“ CONNECTION TO THE MAINS.”